



LANCER TACTICAL



LT-03 SERIES



LT-02 SERIES

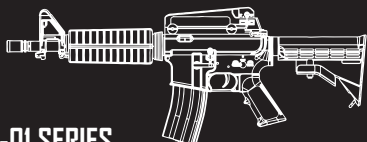

LT-01 SERIES



LT-06 SERIES

GEN 2



LT-04 SERIES



LT-19 SERIES



LT-15 SERIES



LT-12 SERIES

GENERATION 2



Please read instruction manual.
For AGES 18 year and older.

INSTRUCTION MANUAL

SAFETY GUIDELINES

Read through the following safety guidelines and warnings in this manual to ensure safe handling and operation of the airsoft gun. Failure to do so may lead to injury or other serious bodily harm, as well as legal liability and potential damage to the product.

1. EYE PROTECTION

When operating an airsoft gun, you and all participants ***must wear protective eye gear or full-face protection.***

2. DANGERS OF BEING MISTAKEN FOR AN ACTUAL FIREARM

Do not use an airsoft gun as part of a practical joke or prank; you may be punished under federal, state, or local law. ***Never carry or brandish an airsoft gun in any public area.***

3. TRANSPORT & STORAGE

Always have your airsoft gun in a carrying case or bag when transporting between locations.

Always set the selector switch to safe when storing your airsoft gun.

Prior to storing or transporting airsoft gun, always remove the magazine, clear the chamber, and disconnect battery.

4. MUZZLE SAFETY

Never look into the barrel or muzzle of any airsoft gun!

Spontaneous firing may still occur after a misfire, malfunction, or failure to fire.

Always aim the muzzle and barrel of the airsoft gun towards a safe direction.

Never shoot a person or animal under any circumstance.

5. TRIGGER CONTROL

Avoid pulling the trigger carelessly.

Do not place your finger on the trigger when not in use.

Always have the selector switch set to safe when not in use.

6. FIREARM HAZARDS

Always assume the airsoft gun is loaded with BBs.

Do not fire the airsoft gun in an unsafe direction, even if the magazine is removed.

The airsoft gun may still be loaded with BBs even if the magazine is removed, and may still discharge.

7. WARRANTY & CARE

Modifications and alterations to your airsoft gun will void all warranty claims.

Follow proper cleaning of your airsoft gun according to the manual to ensure safe shooting performance.

Warranty does not cover normal wear & tear, nor does it cover abuse of the airsoft gun.

8. ORANGE TIP

The removal or color alteration to the orange tip may be illegal under Federal and State Law (check your region).

The owners and/or users shall assume all risk, and will be held personally responsible for any modifications.

BATTERY INSTALLATION

Rear Installation (for LT-02, LT-03, LT-04, LT-12, LT-15, LT-19 series)

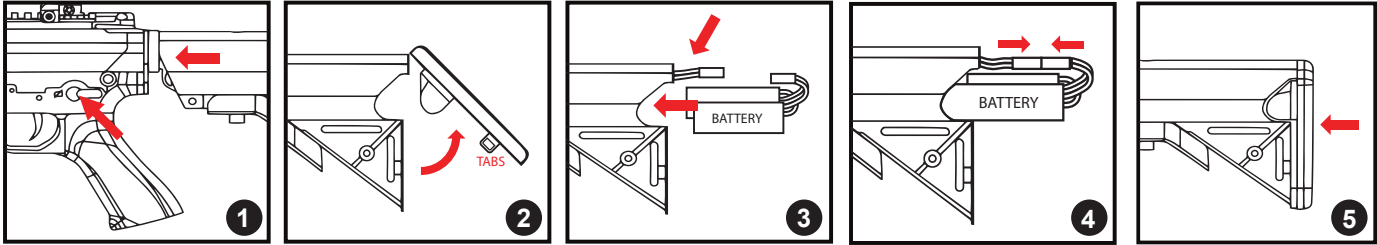

1 Make sure the selector switch is set to safe & fully retract the stock. 2 Push tabs to remove the buttpad. 3 Pull out tamiya battery connector from inside the stock. Slide the battery into stock side compartments. 4 Connect the battery to the connector. 5 Re-insert the battery cover.

Front Installation (for LT-01, LT-06 series)

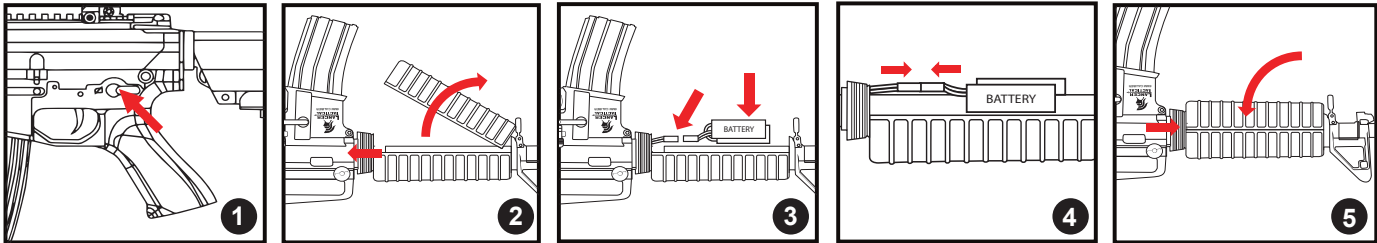

1 Make sure the selector switch is set to safe. 2 Flip over gun. Pull back delta ring and remove lower hang guard. 3 Pull out tamiya battery connector from inside the receiver. Place the battery into the hand guard. 4 Connect the battery to the connector. 5 Re-install the hand guard.

Charging the Battery

Connect the battery to included UL listing wall charger. Directly plug the charger to a regular wall outlet. Charge until the indicator light turns from red to green, then disconnect the battery (overcharging may damage your battery, and potentially other hazards). If battery becomes very hot, safely disconnect your battery from the wall charger immediately. Always store the battery in a cool, dry location; disconnect charger when not in use.

Charging Time for
NiMH Battery:

Battery: 1600mAh = Est. Charge Time:
Charger: 500mAh 4 Hours

PARTS DIAGRAM

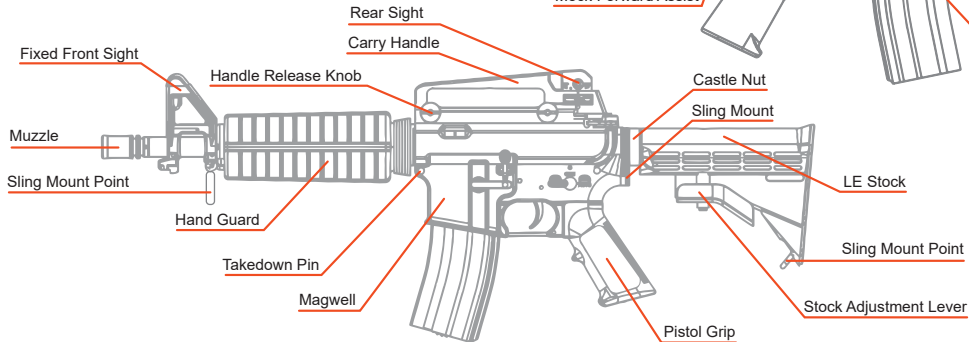
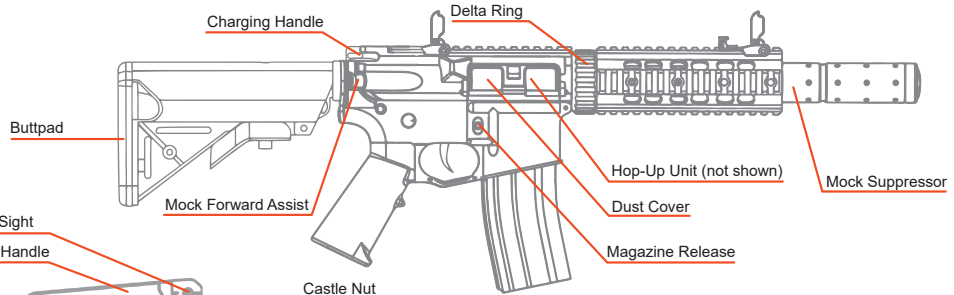
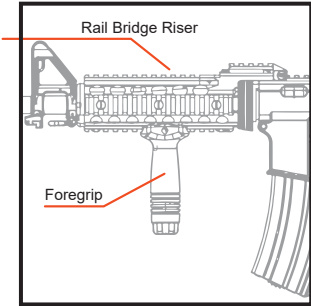
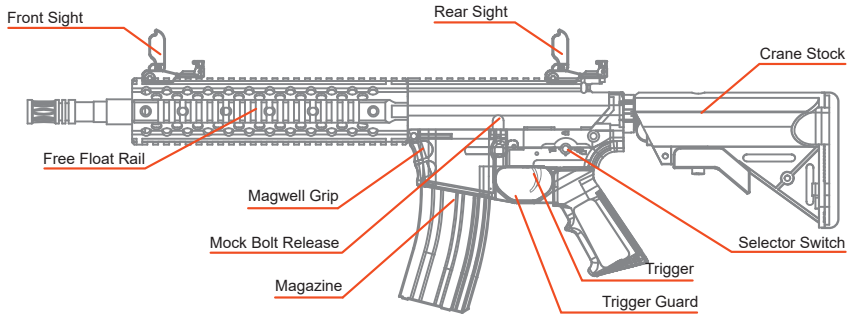

MAGAZINE / SELECTOR SWITCH

Load Magazine

*Lancer Tactical recommends using 0.20g to 0.28g BBs, and is not responsible for damage resulting from the use of underweight or low quality BBs.

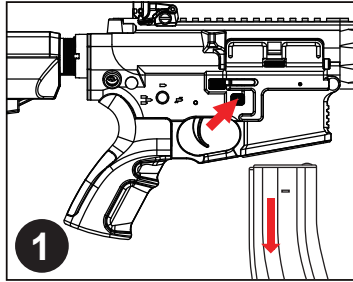

Step 1

Press the mag release button to remove magazine.

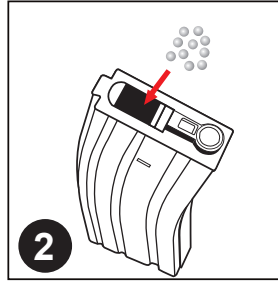

Step 2

Pour BBs into the magazine. Do not overfill. Use high quality 0.20g or heavier BBs.*

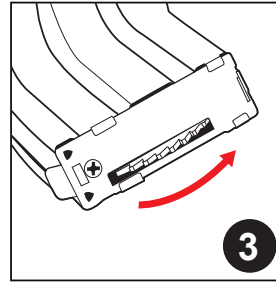

Step 3

Wind the wheel found on the bottom of the mag and listen until you hear a different noise than before. Wind 3 more times.

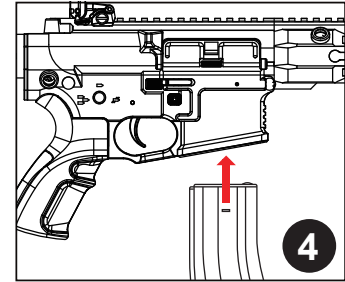

Step 4

Insert the magazine into the airsoft gun until a click is heard, and mag is locked into place.

Selector Switch

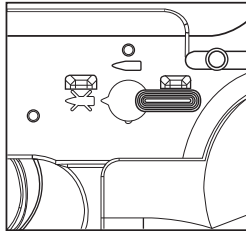

Safe Mode

Always have the selector switch set to safe when not in use. When set to safe, the trigger will not pull and the airsoft gun will not fire.

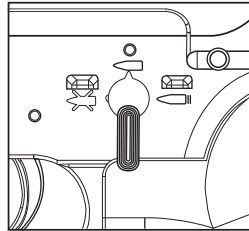

Semi-Auto (Single Shot)

The airsoft gun will fire one single BB each time the trigger is pulled.

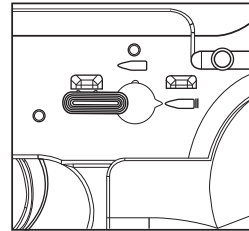

Full-Auto (Continuous Shot)

The airsoft gun will continuously fire as long as the trigger remains pressed.

Quick Tip:

If the trigger is stuck while in semi-auto mode, flip the selector switch to full-auto mode and fire several times to reset the cut-off lever. Low battery power may be the cause for this type of problem.

HOP-UP SYSTEM

Proper adjustment of the hop-up will allow the airsoft gun to reach optimal BB trajectory.

*Always use quality 0.20g or heavier BBs. Lancer Tactical is not responsible for damage resulting from the use of underweight or low quality BBs.

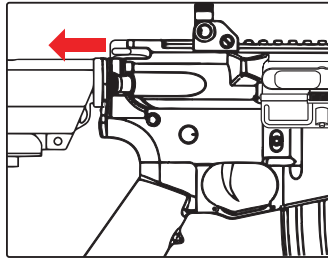

Step 1

Pull the charging handle back to move the bolt plate back, thus exposing the hop-up adjustment dial. Hold in place while adjusting the hop-up.

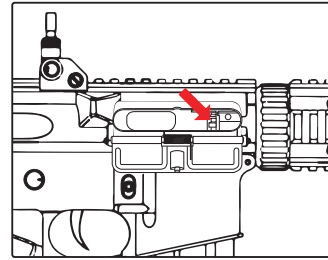

Step 2

Turning the dial affects the amount of hop-up, or "back-spin", of the BBs.

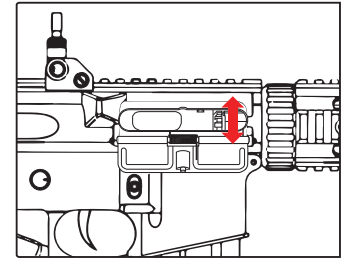

Step 3

Turning the dial downward will cause the BB to float upwards, whereas turning the dial upward causes the BB to fall downward.

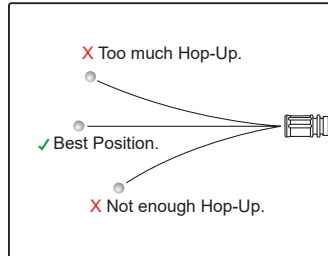

Step 4

Alternate shooting BBs and making adjustments. Adjust the dial until the BBs shoot straight and the longest flying distance is obtained.

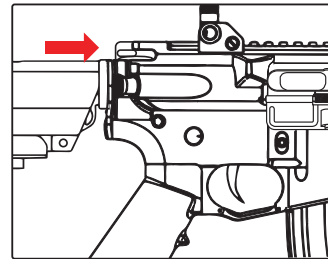

Step 5

When hop-up is fully adjusted, release charging handle to move the bolt plate back to its original position.

DISASSEMBLY (HOP-UP / BARREL / GEARBOX)

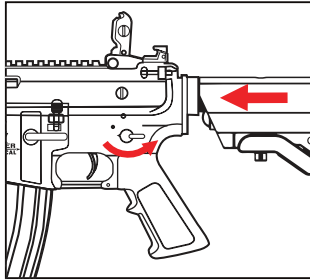

Step 1

Place the selector switch to safe & fully retract the stock.

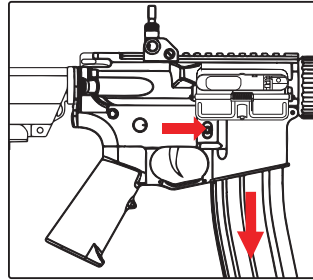

Step 2

Remove the magazine.

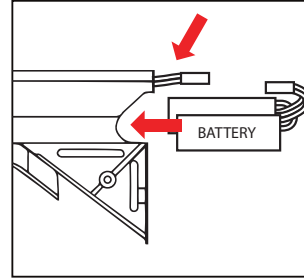

Step 3

Remove the battery (See battery installation page)

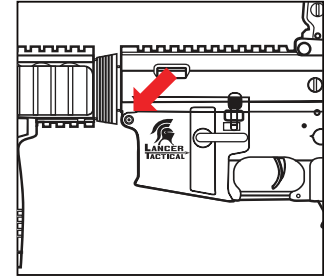

Step 4

Unscrew front pin with hex key. Tap the front body pin out until the upper receiver disconnects.

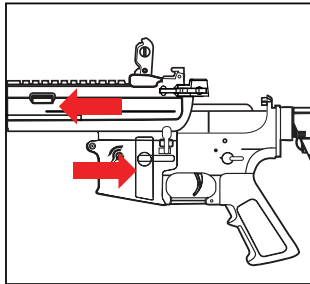

Step 5

Slide the upper receiver away from the lower receiver.

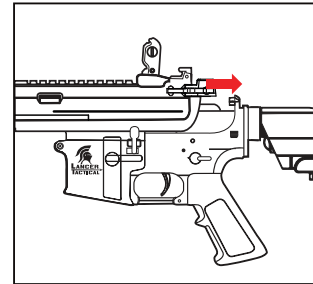

Step 5 (Note)

While sliding upper receiver forward, draw back charging handle to work it past obstructions on top of the internal gearbox.

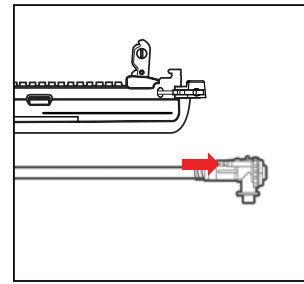

Step 6

Slide the inner barrel and hop-up assembly out of the upper receiver.

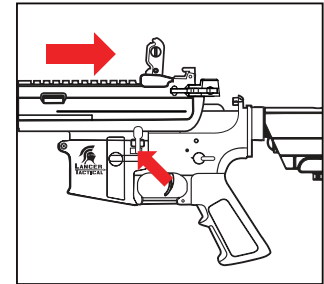

Reassembly Note

While sliding upper receiver back into place, pull changing handle as in Step 5 (Note). And hold down the lower end of the mock bolt release so it does not block the path of upper receiver.

CLEANING

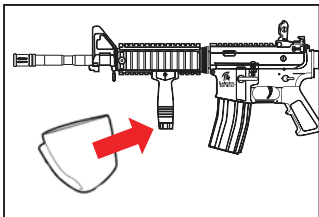

Step 1

Wipe any dirt and dust from the surface of the airsoft gun.

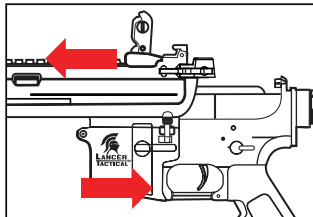

Step 2

Disassemble the airsoft gun as described in the Disassembly Page.

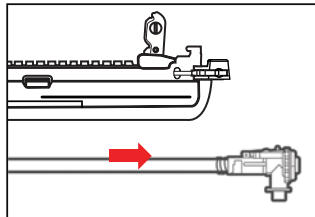

Step 3

Slide the inner barrel and hop-up assembly out of the upper receiver.

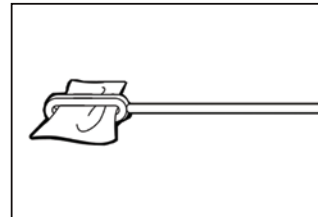

Step 4

Take a 1" cleaning cloth and attach it through the loop-end of the cleaning rod.

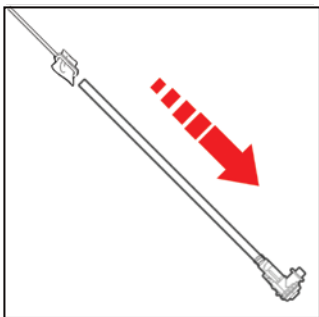

Step 5

Push the cleaning rod through the inner barrel from front to back. Reverse this method to un-jam BBs.

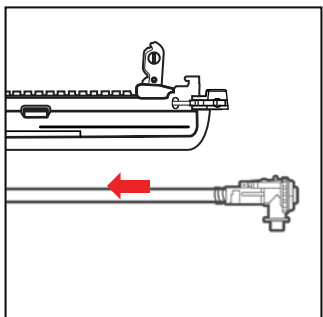

Step 6

Slide the inner barrel and hop-up assembly out of the upper receiver.

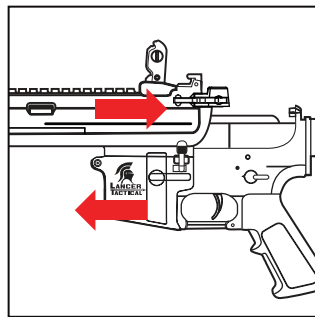

Step 7

Slide the upper receiver onto the lower receiver.

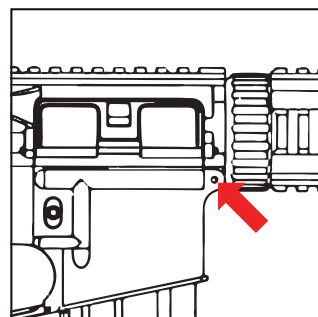

Step 8

Align the front pin with the lower receiver. Push in the pin to secure both receivers.

TROUBLESHOOTING & WARRANTY

Symptoms	Causes	Solutions
Airsoft gun works but no BB output	Magazine feeding issue	Check if magazine is properly loaded into gun ----- Ensure magazine is loaded with BBs ----- Ensure magazine is properly wound
Motor/battery is excessively hot after short usage*	Damaged battery ----- Loose connection terminal ----- Aftermarket battery with too much voltage	Inspect and/or replace battery ----- Contact customer service for tech support ----- Use included battery or comparable 9.6v
Semi- or Full-Auto mode does not operate properly	Battery voltage or discharge is too high ----- Battery charge low or old battery	Condition, charge, or replace battery
Semi- or Full-Auto mode does not operate at all	Disconnecter is not engaged properly	Reset the disconnecter: set the selector to safe, then to automatic, then to semi
Firing cycle is slow	Battery is low on power	Charge or replace battery
High-pitched sound or grinding noise while firing	Motor level is not adjusted properly	Contact customer service or watch how to video by visiting: https://youtu.be/UqpcSe-JuF0
BBs fly upward too much	Hop-Up adjusted too high	Adjust for less Hop-Up (see HOP-UP page)
BBs fly downward too much	Hop-Up adjusted too low	Adjust for more Hop-Up (see HOP-UP page)
Barrel double feeding or BBs are rolling out of the barrel	Excessive grease or oil in the Hop-Up chamber ----- Hop-Up adjusted too low or too high	Fire at least 200 rounds to eliminate excessive grease from the chamber clean Hop-Up with supplied cleaning rod ----- Adjust for more Hop-Up (see HOP-UP page)
Hop-Up system cannot adjust	Hop-Up adjustment arm is not set properly	Reset Hop-Up adjustment arm ----- Contact customer service for instructions
Inner barrel is jamming or is jammed	Use of recycled or low quality BBs ----- Inner barrel is contaminated with BBs or debris	Clear/clean/lubricate inner barrel with cleaning rod and silicone oil (see CLEANING page)
Magazine is not feeding	Magazine has not been wound ----- BBs are lodged inside the magazine ----- Internal obstruction	Wind up the wheel underneath magazine ----- Remove and tap magazine to clear the jam ----- Contact customer service

* Some heat is expected after extended use.

Lancer Tactical offers a limited warranty on all registered products sold by our authorized dealers. This limited warranty covers defects in material and/or workmanship for a period of 30 days from the date of purchase. Proof of purchase must accompany any warranty claim.

Make sure your purchase was made from an authorized dealer before registering your Lancer Tactical product.

For online registration, please scan the QR code provided below, or visit lancertactical.com/warrantyregistration

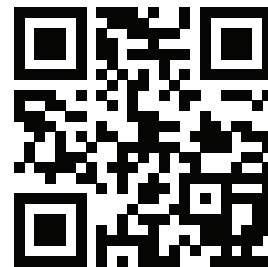

For any customer service or spare parts, please call (888) 279-7776 or email info@lancertactical.com. Business hours are 10am-5pm PST, Monday thru Friday (excluding holidays).



LT-03 SERIES EXPLODED VIEW

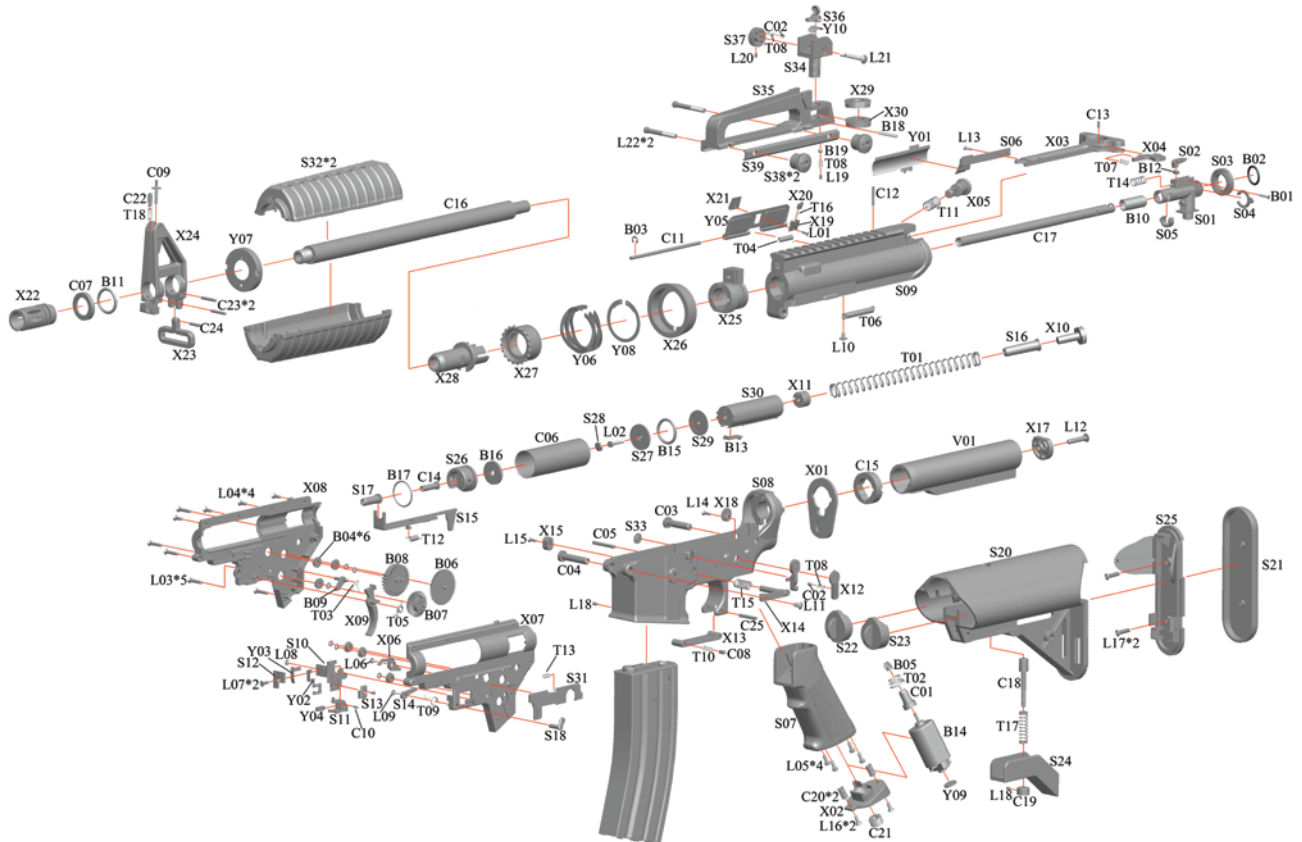

MODEL SPECIFICATIONS

Series	Variations	FPS*	IB Dimensions**	Length	Battery	Hop-Up	Gearbox	Magazine
LT-01 (G2)	Black (LT-01B-G2 / LT-01B-G2NB)	370-390	11", 6.03 mm	26.5" / 29.5"	NiMH 9.6V 1600mAh Nunchuck	Rotary Dial Knob	Version 2 8mm Metal	300 RD Metal High-Cap
	Tan (LT-01T-G2 / LT-01T-G2NB)							
LT-02 (G2)	Black, Low FPS Version (LT-01BL-G2 / LT-01BL-G2NB)	330-345	11", 6.03 mm	27.5" / 30.5"				
	Tan, Low FPS Version (LT-01TL-G2 / LT-01TL-G2NB)							
LT-02C (G2)	Black (LT-02B-G2 / LT-02B-G2NB)	370-390	11", 6.03 mm	26.5" / 29.5"				
	Tan (LT-02T-G2 / LT-02T-G2NB)							
LT-03 (G2)	Black, Low FPS Version (LT-02BL-G2 / LT-02BL-G2NB)	330-345	11", 6.03 mm	27.5" / 30.5"				
	Tan, Low FPS Version (LT-02TL-G2 / LT-02TL-G2NB)							
LT-02C (G2)	Black (LT-02C-G2 / LT-02C-G2NB)	370-390	11", 6.03 mm	26.5" / 29.5"				
	Tan (LT-02CT-G2 / LT-02CT-G2NB)							
LT-03 (G2)	Black, Low FPS Version (LT-02CL-G2 / LT-02CL-G2NB)	330-345	11", 6.03 mm	26.5" / 29.5"				
	Tan, Low FPS Version (LT-02CTL-G2 / LT-02CTL-G2NB)							
LT-03 (G2)	Black (LT-03B-G2 / LT-03B-G2NB)	370-390	14.5", 6.03 mm	31.25" / 34.5"				
	Tan (LT-03T-G2 / LT-03T-G2NB)							
LT-04 (G2)	Black (LT-04B-G2 / LT-04B-G2NB)	370-390	14.5", 6.03 mm	31.25" / 34.5"				
	Tan (LT-04T-G2 / LT-04T-G2NB)							
LT-06 (G2)	Black (LT-06B-G2 / LT-06B-G2NB)	370-390	14.5", 6.03 mm	31.25" / 34.5"				
	Tan (LT-06T-G2 / LT-06T-G2NB)							
LT-12 (G2)	Black (LT-12B-G2 / LT-12B-G2NB)	370-390	14.5", 6.03 mm	29.5" / 32.75"				
	Tan (LT-12T-G2 / LT-12T-G2NB)							
LT-12BK (G2)	Black, Low FPS Version (LT-12BL-G2 / LT-12BL-G2NB)	330-345	14.5", 6.03 mm	29.5" / 32.75"				
	Tan, Low FPS Version (LT-12TL-G2 / LT-12TL-G2NB)							
LT-12BK (G2)	Black (LT-12BK-G2 / LT-12BK-G2NB)	370-390	14.5", 6.03 mm	31" / 34.25"				
	Tan (LT-12TK-G2 / LT-12TK-G2NB)							
LT-15 (G2)	Black, Low FPS Version (LT-12BKL-G2 / LT-12BKL-G2NB)	330-345	14.5", 6.03 mm	31" / 34.25"				
	Tan, Low FPS Version (LT-12TKL-G2 / LT-12TKL-G2NB)							
LT-15 (G2)	Black (LT-15B-G2 / LT-15B-G2NB)	370-390	13.5", 6.03 mm	28.5" / 31.5"				
	Tan (LT-15T-G2 / LT-15T-G2NB)							
LT-15C (G2)	Black, Low FPS Version (LT-15BL-G2 / LT-15BL-G2NB)	330-345	13.5", 6.03 mm	28.5" / 31.5"				
	Tan, Low FPS Version (LT-15TL-G2 / LT-15TL-G2NB)							
LT-15C (G2)	Black (LT-15CB-G2 / LT-15CB-G2NB)	370-390	15.5", 6.03 mm	30.5" / 33.5"				
	Tan (LT-15CT-G2 / LT-15CT-G2NB)							
LT-19 (G2)	Black (LT-19B-G2 / LT-19B-G2NB)	370-390	14.5", 6.03 mm	31" / 34.25"				
	Tan (LT-19T-G2 / LT-19T-G2NB)							
LT-19 (G2)	Black, Low FPS Version (LT-19BL-G2 / LT-19BL-G2NB)	330-345	14.5", 6.03 mm	31" / 34.25"				
	Tan, Low FPS Version (LT-19TL-G2 / LT-19TL-G2NB)							

*Feet Per Second. Range estimate w/ 0.20g BBs **Inner Barrel